

**CODED TOOLS**  
**530A TO 542A**  
**DESCRIPTION**

**TOOL, 530A** "Mfr Disc."  
Replaced by the 560A tool

**TOOL, 532A** "Mfr Disc."  
Replaced by the 532B tool

**TOOL, 532B**

Adjuster

Replaces the 532A tool.

For use on 300-, 304-, 314-, 324-, and similar-type switches and 245-, 254-, 263-, and 264-type relays.

**TOOL, 533A**

Bearing lug adjuster

For use on 300-, 304-, 314-, 324-, and similar-type switches.

**TOOL, 534A**  
**TOOL, 534B**  
**TOOL, 534C**  
**TOOL, 534D**  
**TOOL, 534E**  
**TOOL, 534F**  
**TOOL, 534G**  
**TOOL, 534H**

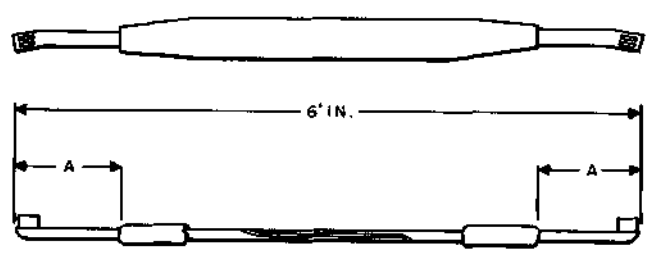

▶ **TOOL, 534J** ◀

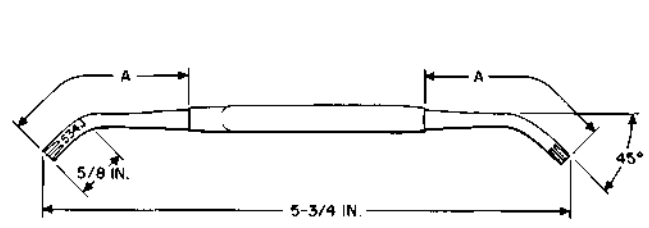

CODE	SLOT WIDTH	DIM. "A"
534A	.025"	1"
534B	.031"	1"
534C	.035"	1"
534D	.043"	1"
534E	.018"	1"
534F	.025"	1-11/16"
534G	.031"	1-11/16"
534H	.043"	1-11/16"
534J	.025"	1- 9/16" ◀

Spring adjusters

534A, 534B, 534C, 534D, and 534E tools are for use on 300-, 304-, 314-, 324-, and similar-type switches.

534D tool is also for use on 266-type relays.

534F, 534G, and 534H tools are for use on AF-, AG-, AJ-, and AK-type relays.

◆534J tool is for use on AM-type relays.◆

**TOOL, 535A**

**TOOL, 535B**

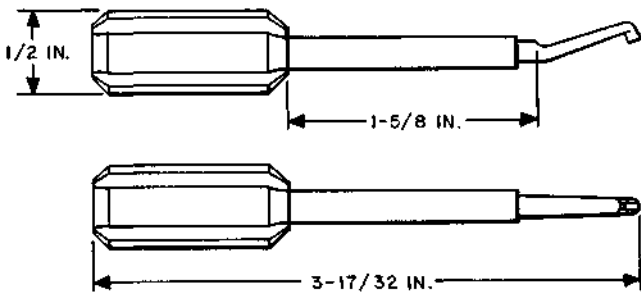

CODE	SLOT WIDTH
535A	.018"
535B	.020"

Spring adjusters

535B tool replaces the D-178348 tool.

535A tool is for use on 300- and similar-type switches, 216-type switches and 245-, 254-, 263- and 264-type relays.

535B tool is for use on KS-13885 readers.

**TOOL, 536A**

"Mfr Disc."  
Replaced by the 536B tool

**TOOL, 536B**

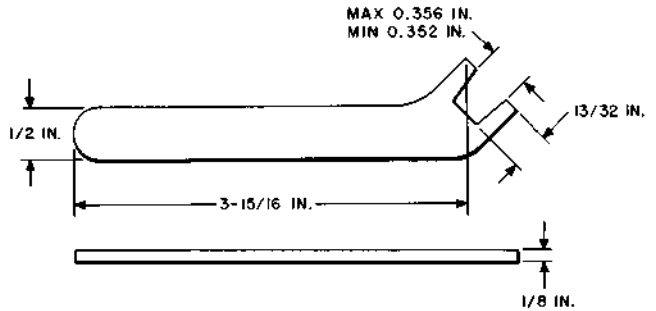

Selecting bar holder

Replaces the 536A tool.

For use on 300-, 304-, 314-, 324-, and similar-type switches.

**TOOL, 537A**

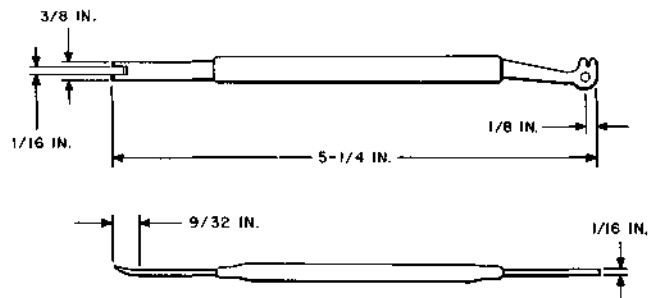

Strap wire tool

For use on 300-, 304-, 314-, 324-, and similar-type switches and 245-, 254-, 263-, and 264-type relays.

**TOOL, 538A**

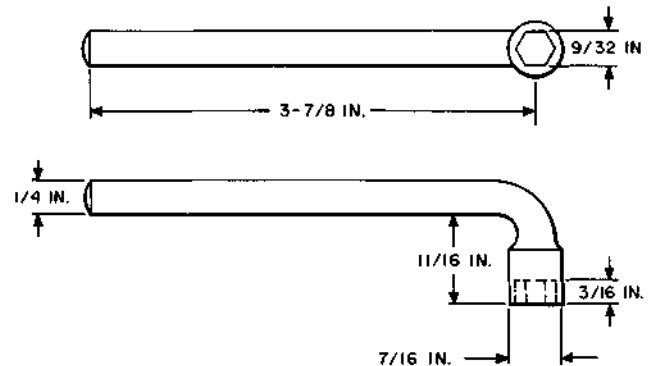

9/32" hex offset socket wrench

For use on 300- and similar-type switches.

**TOOL, 539A**

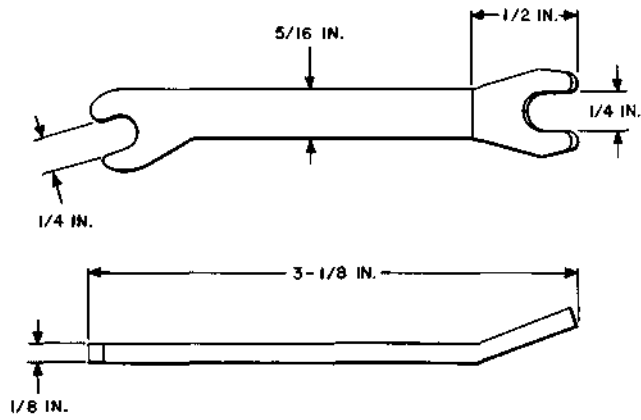

1/4" hex open double-end wrench

◆ For use on 300- and similar-type switches and KS-8543 and KS-8564 timers. ◆

**TOOL, 541A**

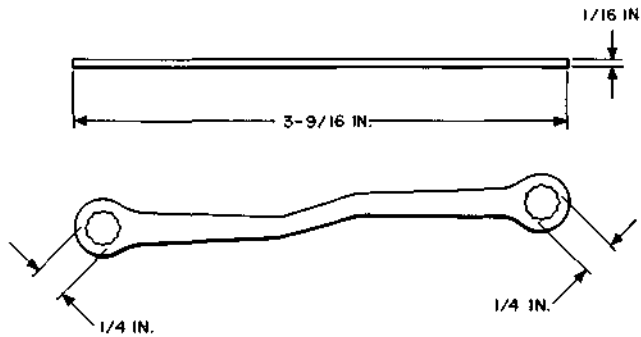

1/4" 12-point double-end box wrench

For general use.

**TOOL, 542A**

"Mfr Disc."  
Replaced by the 558A tool